

GTP-860 II

Digital Processing Tuner/Preamplifier



ADCOM

ABOUT ADCOM

PERFORMANCE AND VALUE

In the world of high performance electronics, Adcom has done the impossible: make state-of-the-art components that are easy to use at an affordable price. In doing this, Adcom has created a revolution in the world of consumer electronics. By creating some of the most renowned components and offering them at affordable prices, Adcom has enabled more people to enjoy their favorite music and movies at top performance levels. Perhaps *Audio Magazine* said it best: "No competing company I know can provide a similar balance of sound quality, power and affordability."

AWARD WINNING

Innovation is our stronghold, and our numerous awards year after year prove that we're never satisfied to rest on our reputation. From our legendary high current amplifiers to our state-of-the-art digital processors, Adcom components consistently impress even the most demanding audiences. Adcom components have won over 25 Product of the Year and Special Recognition citations from Audio Video International, 3 Diapason D'Or Awards, 7 Consumer Electronics Show Design and Engineering Awards, and have appeared on Stereophile's "Recommended Components" lists over 70 times since 1988. A reputation worth its weight in gold.

ENGINEERING PASSION

Every Adcom component is not only designed to reproduce the highest quality sound and picture, but to also deliver the greatest possible value. It is our engineers' passion for perfection that has enabled our components to be judged the equivalent of others costing two, three, or even five times as much. Our engineering team consistently strives to develop and design products that will exceed your expectations. Our goal at Adcom is to let more consumers hear high-end quality sound and see high-end video without paying high-end prices.

All Adcom components are the result of a long-standing dedication to innovation, quality, simplicity and value. Adcom, we have the power, and now so do you.

ADCOM

A division of Klein Technology Group, LLC
8541 East Anderson Drive
Scottsdale, Arizona 85255 USA

Telephone: (480) 607-2277

Fax: (480) 348-9876

Email: info@adcom.com

Web: www.adcom.com

ADCOM is a registered trademark of Klein Technology Group, LLC.

Copyright © 2003 Klein Technology Group, LLC. All rights reserved. No part of this manual may be reproduced or electronically transmitted without the express written consent of Klein Technology Group, LLC.

TABLE OF CONTENTS

WELCOME	2
SAFETY INFORMATION	4
INTRODUCTION & UNPACKING	5
DESCRIPTION OF UNIT	
FRONT PANEL DRAWING	6
1.1 INTERFACE OVERVIEW	6-9
REAR PANEL DRAWING	10
1.2 INPUTS & OUTPUTS SYSTEM CONNECTIONS	10-13
REMOTE CONTROL DRAWING	14
2.1 OVERVIEW OF THE GRC-800	15-17
2.2 REMOTE FUNCTION TABLE	18-19
2.3 PROGRAMMING YOUR REMOTE CONTROL	20-21
2.4 PROGRAMMING MACRO BUTTONS	21
2.5 DISCRETE CUSTOM CODES FOR INSTALLERS	22
SPEAKER PLACEMENT DRAWINGS.....	23
OPERATION & SETUP	
3.1 ON SCREEN DISPLAY	24
3.2 SPEAKER CONFIGURATION.....	24
3.3 DELAY CONFIGURATION	25
3.4 CHANNEL BALANCE AND TEST.....	25
3.5 INPUT CONFIGURATION.....	25
3.6 PROLOGIC II SETUP.....	26
3.7 OTHER SETUP FUNCTIONS.....	26
OTHER INFORMATION	
TROUBLE SHOOTING GUIDE.....	27-28
SERVICE INFORMATION	28
WARRANTY INFORMATION	29
GTP-860II SPECIFICATIONS	31

THE FOLLOWING PRECAUTIONS AND SAFETY INSTRUCTIONS ARE REQUIREMENTS OF UL AND CSA SAFETY REGULATIONS

Warning: To reduce the risk of fire or electric shock, do not expose this unit to rain or moisture.

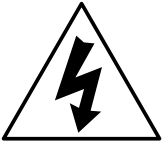
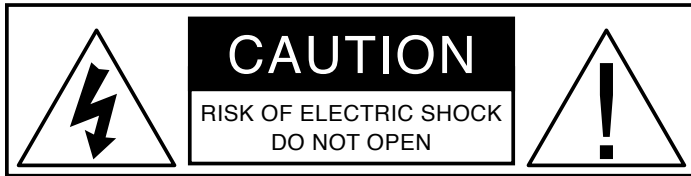

The graphic symbol of a lightning flash with an arrow point within a triangle signifies that there is dangerous voltage within the unit and it poses a hazard to anyone removing the cover to gain access to the interior of the unit. Only qualified service personnel should make any such attempt.



The graphic symbol of an exclamation point within an equilateral triangle warns a user of the device that it is necessary to refer to the instruction manual and its warnings for proper operation of the unit.

Do not place this unit on an unstable cart, stand, tripod, bracket, or table. The unit may fall, causing serious injury to a child or adult, and serious damage to the unit. Use only with a cart, stand, tripod, bracket, or table recommended by the manufacturer or sold with the unit. Any mounting of the device should follow the manufacturer's instructions, and should use a mounting accessory recommended by the manufacturer.

Read all the safety and operating instructions before connecting or using this unit.

Retain this notice and the owner's manual for future reference.

All warnings on the unit and in its operating instructions should be adhered to.

All operating and use instructions should be followed.

Do not use this unit near water. For example, near a bathtub, washbowl, kitchen sink, laundry tub, in a wet basement, or near a swimming pool.

The unit should be installed so that its location or position does not interfere with its proper ventilation. For example, it should not be situated on a bed, sofa, rug, or similar surface that may block the ventilation openings; or placed in a built-in installation, such as bookcase or cabinet, that may impede the flow of air through its ventilation openings.

The unit should be situated away from heat sources such as radiators, heat registers, stoves, or other devices (including amplifiers) that produce heat.

The unit should be connected to a power supply outlet only of the voltage and frequency marked on its rear panel.

The power supply cord should be routed so that it is not likely to be walked on or pinched, especially near the plug, convenience receptacles, or where the cord exits from the unit.

Clean unit only as recommended in its instruction manual.

The power supply cord of the unit should be unplugged from the wall outlet when it is to be unused for a long period of time.

Care should be taken so that objects do not fall, and liquids are not spilled, into the enclosure through any openings.

This unit should be serviced by qualified service personnel when:

- A. The power cord or the plug has been damaged; or
- B. Objects have fallen, or liquid has been spilled, into the unit; or
- C. The unit has been exposed to rain, or liquids of any kind; or
- D. The unit does not appear to operate normally, or exhibits a marked change in performance; or
- E. The device has been dropped, or the enclosure damaged.

**DO NOT ATTEMPT SERVICING OF THIS UNIT YOURSELF.
REFER SERVICING TO QUALIFIED SERVICE PERSONNEL.**

ATTENTION

POUR PREVENIR LES CHOCS ELECTRIQUES NE PAS UTILISER CETTE FICHE POLARISEE AVEC UN PROLONGATEUR, UNE PRISE CE COURANT OU UNE AUTRE SORTIE CE COURANT, SAUF SI LES LAMES PEUVENT ETRE INSEREES A FOND SANS EN LAISSER AUCUNE PARTIE A DECOUVERT.

CAUTION

TO PREVENT ELECTRIC SHOCK DO NOT USE THIS POLARIZED PLUG WITH AN EXTENSION CORD, RECEPTACLE OR OTHER OUTLET UNLESS THE BLADES CAN BE FULLY INSERTED TO PREVENT BLADE EXPOSURE.

CAUTION POWER LINES

Any outdoor antenna must be located away from all power lines.

OUTDOOR ANTENNA GROUNDING

If an outside antenna is connected to your tuner or tuner/preamplifier, be sure the antenna system is grounded so as to provide some protection against voltage surges and built-up static charges. Section 810 of the National Electrical Code, ANSI/NFPA No. 701984, provides information with respect to proper grounding of the mast and supporting structure, grounding of the lead-in wire to an antenna discharge unit, size of grounding conductors, location of antenna discharge unit, connection to grounding electrodes, and requirements for the grounding electrode.

- a. Use No.10 AWG (5.3 mm²) copper, No.8 AWG (8.4 mm²) aluminum, No.17 AWG (1.0 mm²) copper clad steel or bronze wire, or larger, as a ground wire.
- b. Secure antenna lead-in and ground wires to house with stand-off insulators spaced from 46 feet (1.221.83 m) apart.
- c. Mount antenna discharge unit as close as possible to where lead-in enters house.
- d. Use jumper wire not smaller than No.6 AWG (13.3 mm²) copper, or the equivalent, when a separate antenna grounding electrode is used. See NEC Section 810-21 (j).

EXAMPLE OF ANTENNA GROUNDING AS PER NATIONAL ELECTRICAL CODE INSTRUCTIONS CONTAINED IN ARTICLE 810. RADIO AND TELEVISION EQUIPMENT.

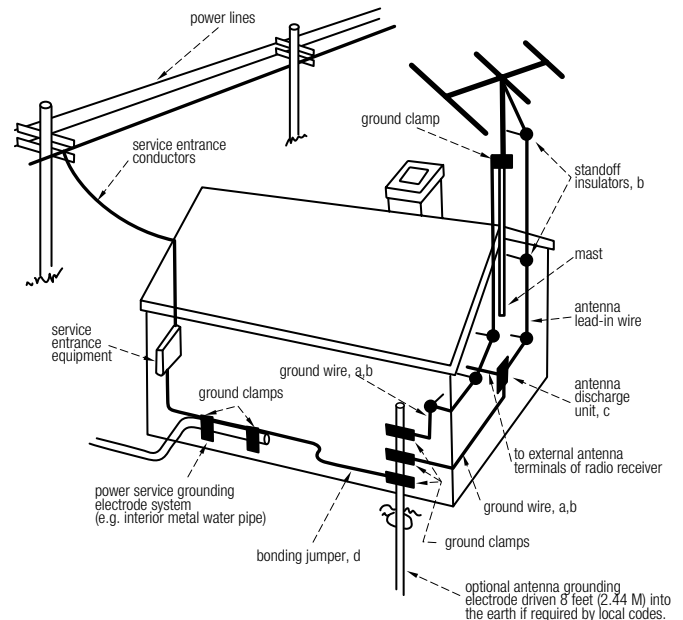

NOTE TO CATV SYSTEM INSTALLER

This reminder is provided to call the CATV system installer's attention to Article 82022 of the National Electrical Code that provides guidelines for proper grounding and, in particular, specifies that the cable ground shall be connected to the grounding system of the building, as close to the point of cable entry as practical.

Congratulations on your decision to purchase the GTP-860II 7.1 tuner/preamplifier. Multichannel audio and home theater are better than ever. Your new ADCOM component was designed to deliver all the impact of your favorite action flick and the subtle harmonic texture that makes high resolution audio amazing. Audition the GTP-860II paired with an ADCOM power amp and DVD player and you will experience what high performance is all about. To realize the full potential of your GTP-860II, and before making any connections to it, please read these operating and installation instructions thoroughly.

Key Features

- Dolby Digital and DTS decoding
- ADCOM 7.1m²
- Component video switching
- 24 bit/192kHz DACs
- RDS tuner
- External 5.1 input
- Torridial power transformer

Unpacking the GTP-860II

Before your new ADCOM preamplifier left our factory, it was carefully inspected for physical imperfections and tested for all electrical parameters as a routine part of ADCOM's systematic quality control. This, along with full operational and mechanical testing, should ensure a product flawless in both appearance and performance. After you have unpacked the GTP-860II, inspect it for physical damage. Save the shipping carton and all packing material as they are intended to reduce the possibility of transportation damage should the preamplifier ever need to be shipped again. In the unlikely event damage has occurred, notify your dealer immediately and request the name of the carrier so a written claim to cover shipping damages can be initiated. The right to a claim against a public carrier can be forfeited if the carrier is not notified

promptly in writing and if the shipping carton and packing materials are not available for inspection by the carrier. Save all packing materials until the claim has been settled.

Placing the GTP-860II

Although the GTP-860II does not generate much heat, it is good practice to ensure the preamplifier's long-term, trouble-free operation to provide adequate ventilation for the unit. Therefore, the GTP-860II should be kept away from external sources of heat such as radiators and hot-air ducts.

We recommend that you exercise care when placing components on top of the GTP-860II. If you are placing a heat producing component (such as an amplifier) on top of or below the GTP-860II, it is recommended that you allow at least three (3) inches vertical spacing for proper airflow.

We also recommend that you leave five (5) inches of space behind the unit for additional airflow and to allow space for interconnects to hang freely.

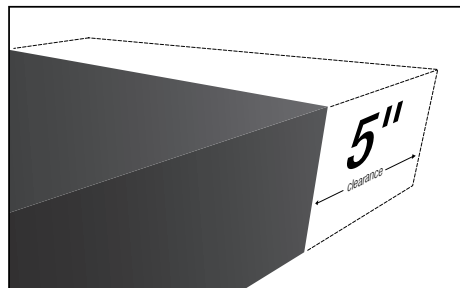

If you observe these recommendations, the GTP-860II will perform reliably in any reasonable environment. You should also pay attention to such normal considerations as protection from excessive dust and moisture.

The optimal performance of your new GTP-860II will ultimately depend on the care with which you make the connections between the amplifier, preamplifier and loudspeakers. All input and output signal connections should be made only with high quality, low-loss, low capacitance cables. For recom-

mendations of the type and quality of interconnections that are best for your applications, consult with your ADCOM dealer.

Safety Information

There are no user serviceable parts inside. Refer all servicing to qualified service personnel.

The unit must be connected to a power supply only of the type and voltage specified on the rear panel. Connect the component to the power outlet only with the supplied power supply cable or an exact equivalent. Do not modify the supplied cable. Do not defeat grounding and/or polarization provisions. The cable should be connected to a 3-pin polarized wall outlet, matching the wide blade of the plug to the wide slot of the receptacle. Do not use extension cords. Do not route the power cord where it will be crushed, pinched, bent, exposed to heat, or damaged in any way. Pay particular attention to the power cord at the plug and where it exits the back of the unit. The power cord should be unplugged from the wall outlet if the unit is to be left unused for a long period of time. Immediately stop using the component and have it inspected and/or serviced by a qualified service agency if:

- the power supply cord or plug has been damaged;
- objects have fallen or liquid has been spilled into the unit;
- the unit has been exposed to rain;
- the unit shows signs of improper operation; or
- the unit has been dropped or damaged in any way.

GTP-860II Front Panel

- [1] Power Button
- [2] Tuner Buttons
- [3] Display Window
- [4] Volume Knob
- [5] Headphone/Vid 5 In
- [6] Surround Backs
- [7] Input Selector
- [8] Surround Mode
- [9] Bass/Treble Knobs

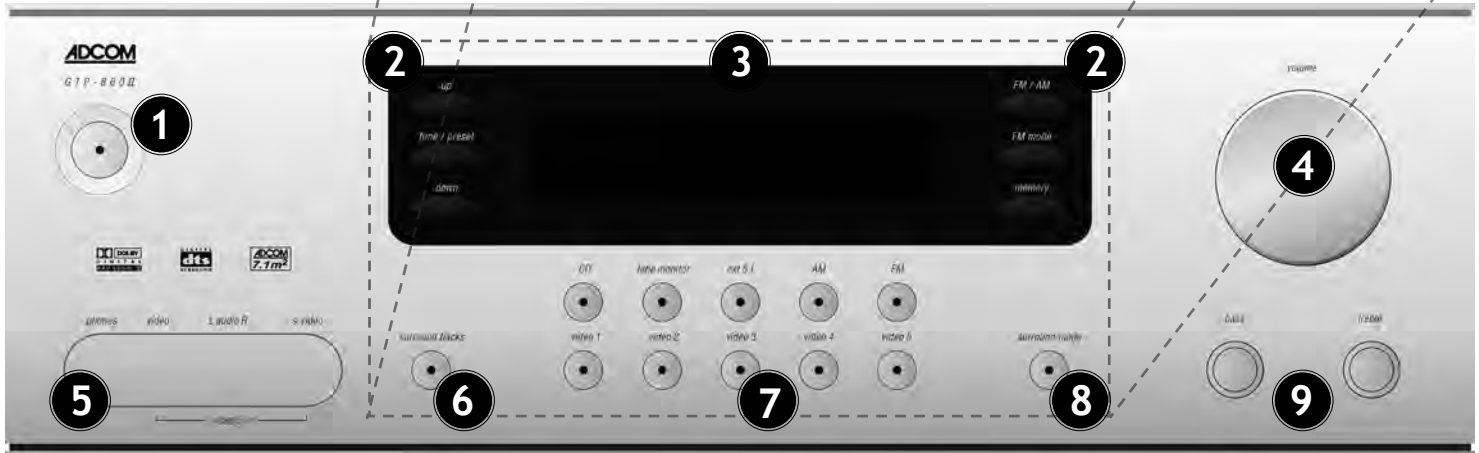

1.0 Description of Unit

1.1 Interface Overview

The GTP-860II's front panel is designed for ease of operation. All controls are logically grouped for easy, intuitive operation. Familiarize yourself with the preceding diagram and read the short explanations of each feature below. When you finish, you will be well on your way to enjoying the GTP-860II's convenience and sound quality.

[1] On/Off Power Switch

Depress the Power button to switch the preamplifier to its On state. The LED in the power button will light up RED. Pressing the Power switch again will turn the unit OFF completely.

If the unit is currently ON, pressing the power button [27] on the remote control, will switch the unit to the standby mode. The front panel indicators will turn off except for the LED in the power button which will turn to an amber color. Press the power button on the remote again to switch the unit from the Stand-By state to the On state, and the last selected

source will be indicated in the display. If the preamp is in the Stand-By state, it can be turned On by pressing any of the input selector buttons on the front panel.

NOTE: In Stand-By mode the GTP-860II uses very little power. However, it is recommended that you switch the unit completely off if it is not going to be used for more than a couple of days. Turn the unit Off by pressing the Power button on the front panel. All lights will extinguish. When the GTP-860II is plugged into the wall current may still be flowing into the transformer. Only when the GTP-860II is unplugged is all current into the device stopped.

[2] Digital Tuner Controls

FM/AM Button: Toggles between AM and FM frequency bands.

FM Mode Button: Sets the FM tuner to mono mode. The letter "M" appears next to the tuner preset number in the front panel display. Pressing the button again returns the FM tuner to stereo mode.

The letter "S" will appear ONLY when a stereo station has been locked by the Digital Tuner. A flashing "S" indicates that the particular chosen station signal strength is not strong enough for the Digital Tuner to "lock" onto the stereo signal. In this instance, the user may want to consider placing the tuner into mono mode.

Memory Button: Pressing this button when FM or AM is selected as the input source memorizes the current station frequency into one of the presets. You can preset up to 32 stations.

Tuner Up/Down Buttons: The function of these buttons depends on the tuning mode selected with the tune/preset button.

In preset mode (indicated in the display area): Press the down button to scroll to a lower number preset; press the up button to scroll to a higher preset number. This is a "wrap-around" function, so that going from the highest number preset, the tuner will go to the lowest preset number or vice-versa when tuning either up or down.

In tune mode: Press the up or down button for more than 1/2 second to engage automatic tuning respectively up or down the frequency band. The tuner will search automatically for the first reasonably strong radio station, where it will stop. Press the down/up button again for 1/2 second to start searching again.

The GTP-860II tuner can receive AM, FM and FM stereo broadcasts. Up to 32 stations can be preset and accessed

from the front panel or remote. Stations can also be tuned manually.

NOTE: Tuner reception cannot take place unless an appropriate AM and/or FM antenna is connected to the rear panel of the GTP-860II.

To operate the tuner:

1. Press the tuner button on the remote control once, or press the FM or AM button on the front panel.

The display indicates that the tuner is in FM or the AM mode, with stereo selected as the surround mode. The number displayed next to the tuner text is the preset number currently selected or last selected, followed by the stereo reception indicator if the station is being received in stereo. The numbers next to the FM text are the frequency of the selected preset or station. The numbers in front of the dB indication are the current volume setting.

2. Press the AM/FM button on the remote control or the front panel to change between AM and FM bands.
3. Use the tune buttons on the front panel or the remote to change the tuner frequency. The new frequency will be displayed to the left of the volume level on the front panel display.

Pressing a tune button once increases or decreases the FM frequency by .05 MHz and the AM frequency by 10 KHz.

4. Press and hold either the of the tune buttons on the front panel or the remote to scan continuously up or down the selected band. The tuner will stop on the next available station when you release the button.

5. Press the FM mode button on the front panel to toggle between stereo and mono.

If an FM station produces lots of noise or sound that cuts in and out while in stereo, use this control to change the FM mode from stereo to mono.

If you select mono as the operating mode an indicator will appear next to the preset number.

To preset a radio station into memory:

1. Tune to the radio station you desire.
2. Press and the memory button on the front panel to store a station into a preset location. The display will change to show the word "memory" along with a flashing number.
3. Use the up and down buttons on the front panel to select the numeric memory location in which to store this station. To complete the process push the memory button on the front panel a second time. Up to 32 stations can be stored, randomly between AM and FM, in memory as presets.

To select a radio station that you have preset:

1. Set the GTP-860II to tuner.
2. Push the tune/preset button until the preset mode is selected.
3. Use the up and down buttons to navigate through the list of presets that are programmed into the GTP-860II

To change a preset radio station:

1. Tune to the new radio station you desire.
2. Press and hold the mem button on the front panel. The display will change to show the word "memory" along with a flashing number.
3. Quickly enter the new preset/memory location (01 through 32) using the up and down buttons on the front panel. This replaces the previously memorized preset with your new selection.

[3] Display Window

The display area shows all vital information when the unit is operational.

[4] Volume Knob

The Volume control adjusts the overall loudness of the signals being fed to the preamplifier outputs. Unlike conventional controls, the GTP-860II's volume control doesn't have a start or end position. Volume can also be adjusted from the remote control using the Master Volume Up or Down buttons [31]. The Volume control does not affect recordings made using the Tape, Video 3 and Video 4 outputs but will affect the signal going to the Preamp Outputs. The volume level is indicated in the lower right hand side of the front panel display and on the OSD(On Screen Display).

On the remote control, press the Mute button [29] to temporarily switch off the sound to the Preamp outputs and headphones. Mute mode is indicated by "MUTE" in the display area. Press Mute again to restore sound. Mute does not affect recordings made using the Tape, Video 3 and Video 4 outputs but does affect the signal going to the Preamp Outputs.

[5] Headphone Output/ Video 5 Input

A 1/4" stereo jack socket is provided for headphone listening and will work with conventional headphones of any impedance. The volume and tone controls are operative for headphone listening. Use a suitable adapter to connect headphones with other types of connectors such as 3.5mm stereo 'personal stereo' jack plugs. Inserting a headphone will automatically turn off the signals from the Preamp Outputs, and set the listening mode to Stereo.

REMEMBER: Listening at high levels can damage your hearing.

The video five input is located on the front panel to simplify connection of a camcorder or a video game console. To select video five, push the corresponding front panel button in the input selector section.

[6] Surround Backs

Pressing this button engages ADCOM's proprietary 7.1m²™ decoding algorithm as long as the surround back speakers have been turned on in the speaker setup section of the OSD. The 7.1m²™ decoding process mixes the signals from the left surround and right surround channels to derive two unique signals sent to each back output. The benefit of our 7.1m²™ decoding process is enhance imaging between the surround speakers and the creation of a more diffuse ambient sound field. The 7.1m²™ process has the same benefits when compared to other matrix decoding as stereo signals have over mono signals. The 7.1m²™ process can also be used to drive your surround back speakers when you are listening to an externally decoded DVD audio or SACD multi-channel disc. Due to the varying nature of film soundtracks and music, you may prefer to activate or deactivate the surround back channels. For example, Dolby Digital 5.1 and DTS soundtracks benefit greatly from the addition of the 7.1m²™ processing. Pro Logic soundtracks on the other hand provide a mono surround signal track, which yields a less satisfying experience when using the surround back channels.

The level of the Surround Back channels can be adjusted in the same manner as the other channels, either through the On-Screen-Display (OSD) or with the Bal. or Test functions from the remote control. Be sure to experiment to find the balance that best suits your taste.

[7] Input Selector

These buttons select the active video and audio input for the GTP-860II. The source that is currently selected will be shown on the top line of the front panel display and the LED in the source button will be red. On the left side of the bottom line of the front panel display the current type of audio input will be displayed. The audio input can be assigned to the input select buttons using the setup function as described in section three of this manual. The currently selected source signal is sent to the main preamp outputs after processing and the video 3, video 4, aux and tape outputs. Video signals associated with an input give priority to s-video sources over composite video signals. The video one and video two inputs also have component video switching capabilities. This component video switching is independent of the composite/S video signal and does not support on-screen display messages.

Ext 5.1: Selects the multi-channel output signal from a DVD player or external decoder source (such as DVD-Audio) connected to the ext 5.1 input as the active input. This function can be selected for each source using the On screen setup functionality as described in section three of this manual.

Tape Monitor: Selects the output from a tape recorder when playing back tapes or monitoring recordings being made through the Tape sockets. Press the Tape Monitor button once to select it and again to return to the normal input selection.

The Tape Monitor function does not override the current input selection that is sent to the tape outputs. When the Tape Monitor is selected, you are listening to the signal that is coming back into the Tape Input jacks. The currently selected source is still being sent to the Tape Out where it can be recorded. This

function enables you to check on a recording that you are making without affecting the recording process. When Tape Monitor is selected, the button will remain lit until Tape Monitor is disengaged again. This function is only active when a stereo analog source is selected.

[8] Surround Mode

With the Surround Mode button the available surround sound modes can be selected. The selected surround mode is permanently indicated in the display area on the right side of the top line of the display. The Surround Mode button scrolls through the available surround sound modes when pressed repeatedly.

The surround modes are:

Stereo: The Stereo mode provides signals to the front left and right speakers and possibly the subwoofer.

Hall: In the Hall Surround mode, a realistic level of ambiance is added to a normal stereo source such as a CD or FM radio.

Pro Logic II: Dolby Pro Logic II is the new advanced version of Pro Logic, Dolby's original surround matrix with center channel output. Pro Logic II has enhanced imaging and wider bandwidth surround signals than original Pro Logic. Dolby Pro Logic II

is intended for use with most movies and television programs that are designed to be listened to using Pro Logic decoding. In addition to the standard Dolby Pro Logic II, which is known as Prologic II Cinema(PLII-C). "Pro Logic II Cinema"(PLII-C) is optimized for movies and television. The GTP-860II supports two other versions of Pro Logic II processing, which were designed for specific types of programs. "Pro Logic II Music" (PLII-M) mode was designed for use with regular stereo recordings and it can utilize all your speakers in your system when listening to a CD. "Pro Logic II Panorama" (PLII_P) is a version of Pro Logic II that is intended for use with movie playback that spreads the images from the front left and right speakers around to the surround speakers. The original Pro Logic processing mode is also available.

5 ch Stereo: This mode is designed for use with stereo program material. It is designed to get maximum output from all your speakers. The rear speakers are driven with the same signal as the front left and right, while the center speaker is a monophonic summation of the front speakers.

With any of the Digital Inputs, the GTP-860II automatically recognizes

if the selected source carries a Dolby Digital™ or DTS™ signal. Dolby Digital and DTS have six independent channels available in total: Left, Center, Right, Surround Left, Surround Right and an "Effects Channel" (Subwoofer). With either Dolby Digital 5.1 or DTS digital input, the Stereo, Dolby Pro Logic and Hall surround modes cannot be selected. The Dolby Digital signal allows for several channel configurations. Most two-channel Dolby Digital recordings will allow the Pro Logic listening mode to be applied. If the GTP860II detects a Dolby Digital™ or DTS™ signal it will be indicated on the front panel display in the surround mode section.

[9] Bass/Treble Controls

The GTP-860II is fitted with Bass and Treble tone controls to adjust the overall tonality of your system. The 12 o'clock position is 'flat' with no boost or cut and a detent indicates this position.

Rotate the control clockwise to increase the amount of Bass or Treble. Rotate the control counter-clockwise to decrease the amount of Bass or Treble. These controls affect the Left and Right Front channels. The Tone controls do not affect recordings made using the Tape or Video line outputs.

GTP-860II Rear Panel

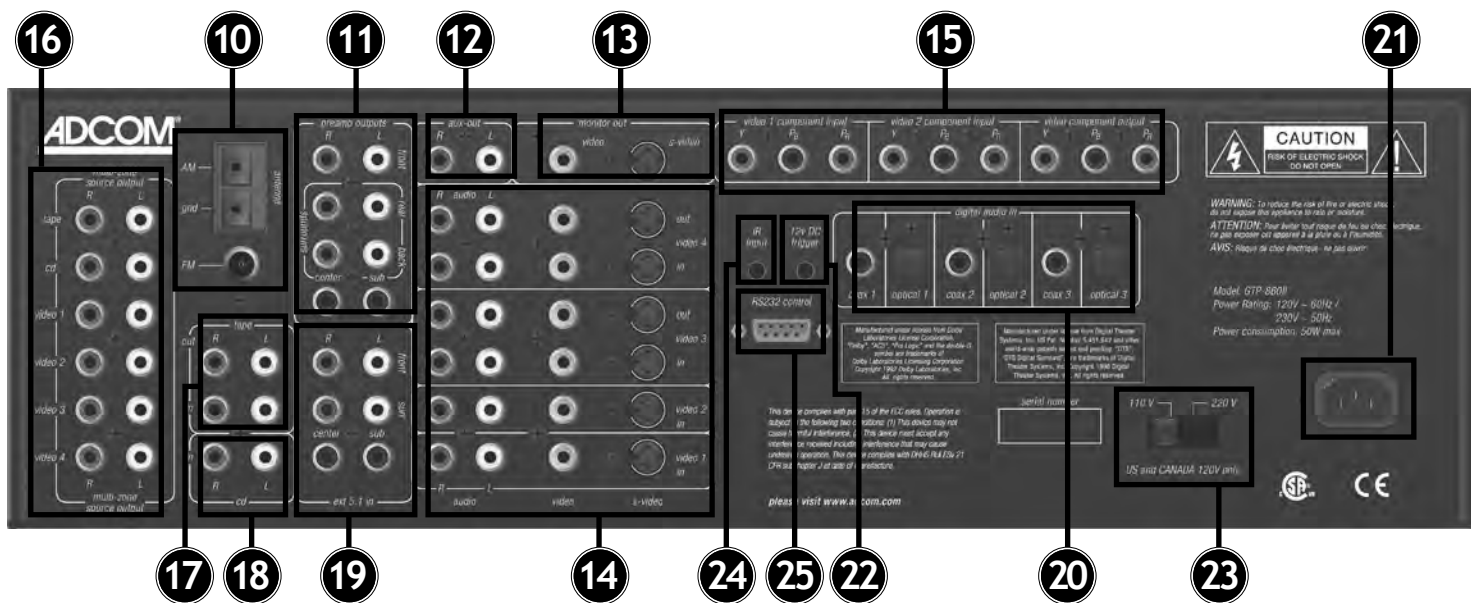

[10] Antenna Connections

[11] Preamp Outputs

[12] Auxiliary Outputs

[13] Monitor Outputs

[14] Video/Analog Audio Inputs & Outputs

[15] Component Video Inputs & Output

[16] Multi-Zone Source Outputs

[17] Tape Inputs/Outputs

[18] CD Analog Inputs

[19] Ext. 5.1 Analog Input

[20] Digital Audio Inputs

[21] AC Power Cord

[22] 12V DC Trigger

[23] Voltage Switch

[24] IR Input

[25] RS232 Control Input

1.2 Inputs & Outputs System Connections

Like the front panel, the GTP-860II's rear panel is carefully arranged to make hookup, configuration, and use as simple as possible. However, the GTP-860II's capabilities take some study to use most effectively. We strongly suggest that you read this section of the manual before beginning to hook up your system. You will save yourself much time and effort if you carefully think out what you expect from your system: consider the components you will use, where they'll be placed, and how you will want them to work together. The diagrams and notes in this section will probably answer most of your questions about

interfacing the GTP-860II with other components in your system.

Note that the GTP-860II's RCA-style jacks have color-coded centers to make connections easier. Use this key to help route cables properly:

RED centers = RIGHT CHANNEL ANALOG AUDIO inputs or outputs

WHITE centers = LEFT CHANNEL ANALOG AUDIO inputs or outputs

YELLOW centers = VIDEO inputs (composite)

BLACK centers = DIGITAL AUDIO inputs, CENTER CHANNEL and SUBWOOFER inputs and outputs

[10] Antenna Connections

AM Antenna: An AM loop antenna is supplied with the GTP-860II and is required for AM reception. Open the clip terminal lever and insert the wire from the antenna. Closing the lever will lock the wire in place. Test various positions for the antenna, but always ensure the loop is placed vertically for best reception. Placing the antenna close to large metal items such as metal shelves or radiators may interfere with reception.

NOTE: When reception is not satisfactory using the supplied AM loop antenna alone, connection of an external antenna is recommended. The antenna cable to the loop antenna must not exceed three meters.

FM Antenna: A ribbon wire FM antenna is included and should be connected to the FM connector at the rear of the unit using the 'balun' adapter supplied. The ribbon aerial should be mounted on a vertical surface and placed so that it forms a 'T'.

Experiment with placement of the antenna to find the position that gives the best signal strength and lowest background noise. An inadequate FM signal normally results in high levels of hiss, especially in stereo, and interference from external electrical sources. In areas of poor FM reception, the tuner section's performance can be improved by using an externally mounted FM antenna. A qualified aerial installer will be able to advise and fit a recommended aerial for your reception conditions.

[11] Preamp Outputs

Before making any connections, check that the GTP-860II and the power amplifiers it will be connected to are switched off. Connect the RCA-to-RCA leads from the Front Left and Right, Center, Surround Rear Left and Right, and Surround Back Left and Right Preamp Outputs to your external amplifiers. The subwoofer preamp output allows for connection to a sub-bass speaker system with its own external or integrated power amplifier ("active" or "powered" subwoofers).

With volume turned down to a low level, switch power on only after all connections have been made.

[12] Auxiliary Outputs

The auxiliary outputs allow a line level connection to various devices, such as an audio system in another room. The output is the selected source.

[13] Monitor Outputs

Composite Video and S-Video outputs are for connecting a TV or Video Monitor to view video sources connected to Video 1 through Video 5. Using a Video RCA-to-RCA lead or S-Video,

connect the 'Video Line In' on the TV or monitor to the MONITOR OUT.

Note that an S-video input signal will also be available as a composite video signal on the Monitor out if the corresponding source is selected. Composite video input signals will also be available as S-Video signals on the Monitor output.

The video signal available on the S-Video and Video Composite outputs is dependent on the selected video input (Video 1, Video 2, Video 3, Video 4, Video 5). However, when one of the audio-only sources is selected (FM, AM, CD, Tape Monitor or ext 5.1) the last selected video signal from one of the video inputs will be present on these outputs. This way you can watch a DVD player or video while using the 5.1 analog audio inputs from a DVD player, as you might do when listening to a DVD-A or SACD disc.

[14] Video/Analog Audio Inputs & Outputs

Apart from the audio signal, these inputs will also accept a video signal which will be routed to the Monitor Out sockets [13] for a television or video projector. Composite connection (using the yellow RCA socket) or an S-Video connection (using the Mini-Din connector) is available.

The S-Video standard allows for higher quality video signal transfer when compared to the Video Composite standard. If your video components have an S-Video connector use dedicated S-Video leads to connect them to the GTP-860II in the same way as described with the Video Composite equivalents.

A video signal fed to an S-Video input socket will be available on both the S-Video Monitor Out and Video Composite Monitor Out.

Video 1 & Video 2: Inputs for the audio playback and video signal from

a video device such as a stereo TV, DVD player, satellite cable TV receiver or a Laser Disc. Using twin RCA-to-RCA leads, connect to the left and right 'Audio Out' of the video device to these inputs. Using a single RCA-to-RCA lead (Video Composite) or S-Video lead, also connect the video output of the video device. Video 1 & Video 2 can be used for video playback only. Use Video 3 or Video 4 if you want to connect a VCR for recording and playback through the GTP-860II.

Video 3 & Video 4: Connections for the audio recording and playback to a VCR or other video recorder. Using twin RCA-to-RCA leads, connect to the left and right 'Audio Out' of the VCR to the Video 3 or Video 4 IN connectors for playback. Connect the left and right 'Audio In' of the VCR to the Video 3 or Video 4 OUT connectors for recording. Using a single RCA-to-RCA (Video Composite) lead or S-Video lead, also connect the video output of the VCR to Video In for Video playback. Connect the Video Input of the VCR to Video Out of the GTP-860II preamplifier for recording of video signals.

[15] Component Video Inputs & Output

The GTP-860II can switch between two sources with component video output. The "video 1" and "video 2" sources have the capabilities to accept component video signals. Each component video signal uses three RCA type connections (Y-green plug, P_B - blue plug, and P_R - red plug), all three connections should be made for optimum video performance. Be sure to use high quality video specific cables for connection. The Component video connection is independent from the S-Video/Composite video jacks. In order to maximize signal quality, no On-screen text will appear on the component outputs. The "video component output" jacks should be connected to component video input on your TV.

[16] Multi-Zone Source Outputs

These output jacks provide a duplicate of the analog audio signal that are connected to Video 1-4, CD and Tape inputs. They are designed to allow the user to interface the sources connected to the GTP-860II with an external stereo receiver or tuner/preamplifier to facilitate multi-zone operation. When using the GTP-860II in conjunction with the GTP-506/GFA-6006 (a three room stereo tuner-preamplifier and amplifier combination) the user can deliver sound to three additional rooms using the same source components hooked up to the GTP-860II. See drawing on next page (page 13) for details.

[17] Tape Inputs/Outputs

Connections for analog recording and playback to an audio tape recorder of any type, such as a cassette, reel-reel, DAT, MD or CD-R. Using twin RCA-to-RCA leads, connect to the left and right 'Audio Output' of the tape machine to the TAPE IN connectors for playback. Connect the left and right 'Audio Input' of the tape machine to the TAPE OUT connectors for recording.

[18] CD Analog Inputs

Input for CD player (analog audio signal) or other line-level signal source. Use a twin RCA-to-RCA lead to connect the CD player's left and right 'Audio Outputs' to this input.

[19] External 5.1 Analog In

Inputs for the multi-channel audio signals from an external decoder, such as an SACD or DVD-Audio player with integrated decoder. Use two twin RCA-to-RCA leads to connect the decoder's front left and right 'Audio Outputs' to the Front left and right inputs, and the decoder's Surround left and right outputs to the Surround left and right inputs. Use a third twin RCA-to-RCA lead to connect the

decoder's subwoofer output to the Subwoofer input and the decoder's Center channel output to the Center channel input. Make sure to follow color coding of the plugs to ensure that both Center and Subwoofer are connected correctly; for instance, use the red plugs at either end to connect the center channel and the white plugs for the subwoofer channel.

[20] Digital Audio Inputs

Use these inputs to connect the coaxial and optical digital audio signal output from such digital devices as CD, DVD or LD players. These inputs are fully assignable using the OSD.

[21] AC Power Cord

After you have completed all connections to the amplifier, plug the AC line cord into a "live" wall socket.

[22] 12V DC Trigger

To facilitate remote turn-on and turn-off of other components (power amplifiers, for example), this 3.5mm mini-jack provides a constant signal (12 volts DC) whenever the GTP-860II is fully powered. When the GTP-860II is turned off (via the front panel switch) or placed in standby mode (via the "power" button on the remote control), the jack has no output.

[23] Voltage Switch

The GTP-860II can be configured for either 120V or 230V operation using this switch. Extreme caution must be used when changing the voltage of the unit, as an incorrect voltage selection will cause severe damage to the unit. See your dealer or contact ADCOM for more details regarding the operation of this switch.

NOTE: We strongly recommend the use of our surge suppressor/line conditioners, the ADCOM ACE family of products, for systems with substantial amplifiers and many source components. The ACE products relieve the GTP-860II from handling large current surges, while they protect your entire

system by filtering and conditioning the AC current. In addition to the numerous heavy duty AC outlets of the ACE-315, the ACE-615 includes sequential power-up and power-down modes to minimize "thumps" whenever you turn your system on or off.

[24] IR Input

The IR input allows hook up of an external IR sensor that sends IR information to the microprocessor in the GTP-860II. This feature can be very useful if the GTP-860II is placed behind a non transparent door or is used with an after market remote control system.

[25] RS232 Control (dB 9)

Allows control of the GTP-860II via computer or home automation system.

Connecting a Multi-Zone Source

The drawing above illustrates the proper hook-up to provide audio to multiple zones using a signal source with the GTP-860II. As illustrated

above we use a GTP-506 and GFA-6006 to distribute the audio source, an ADCOM GCD-750 CD player. Referenced from page 12, [16].

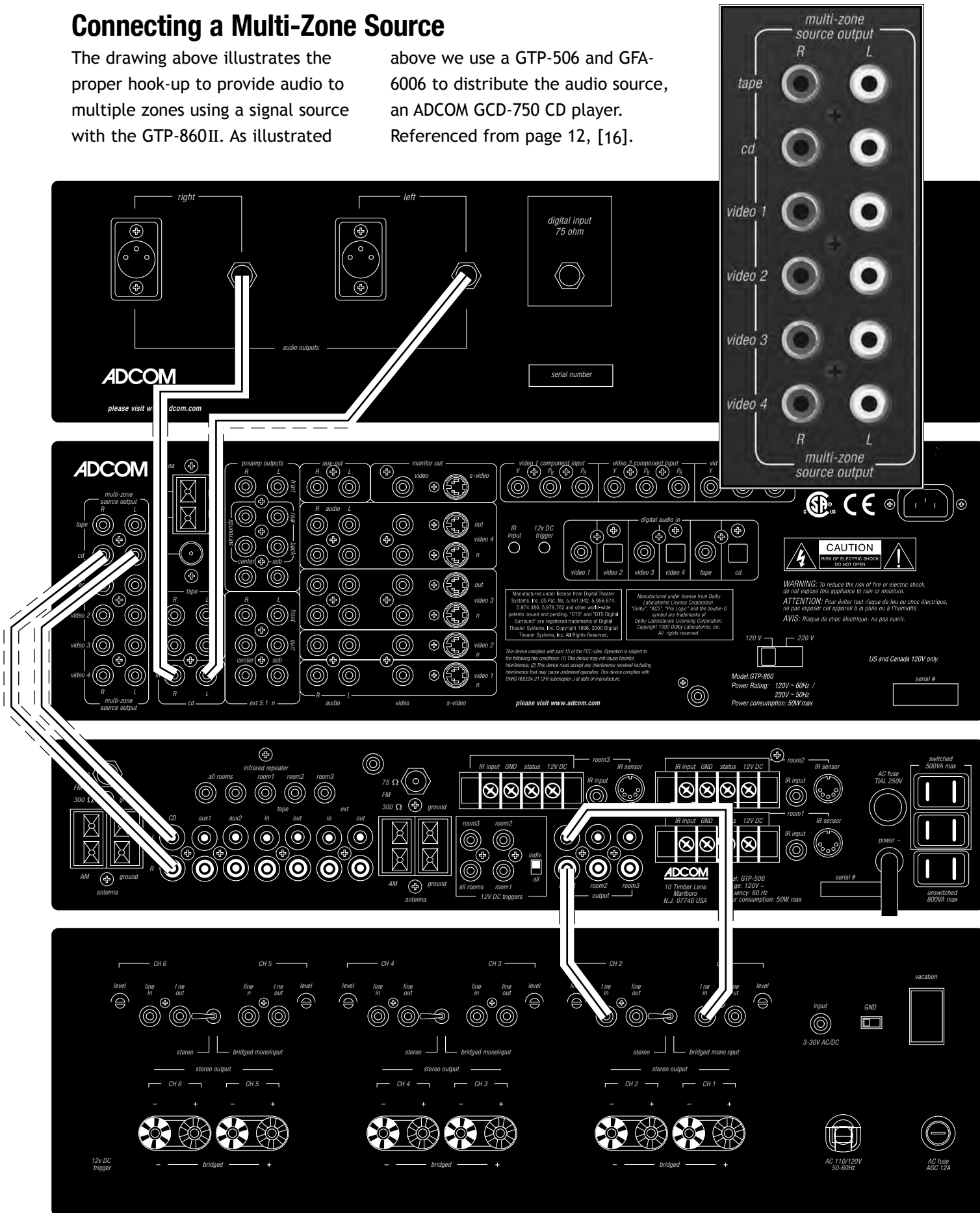

2.0 GRC-800 Remote Control

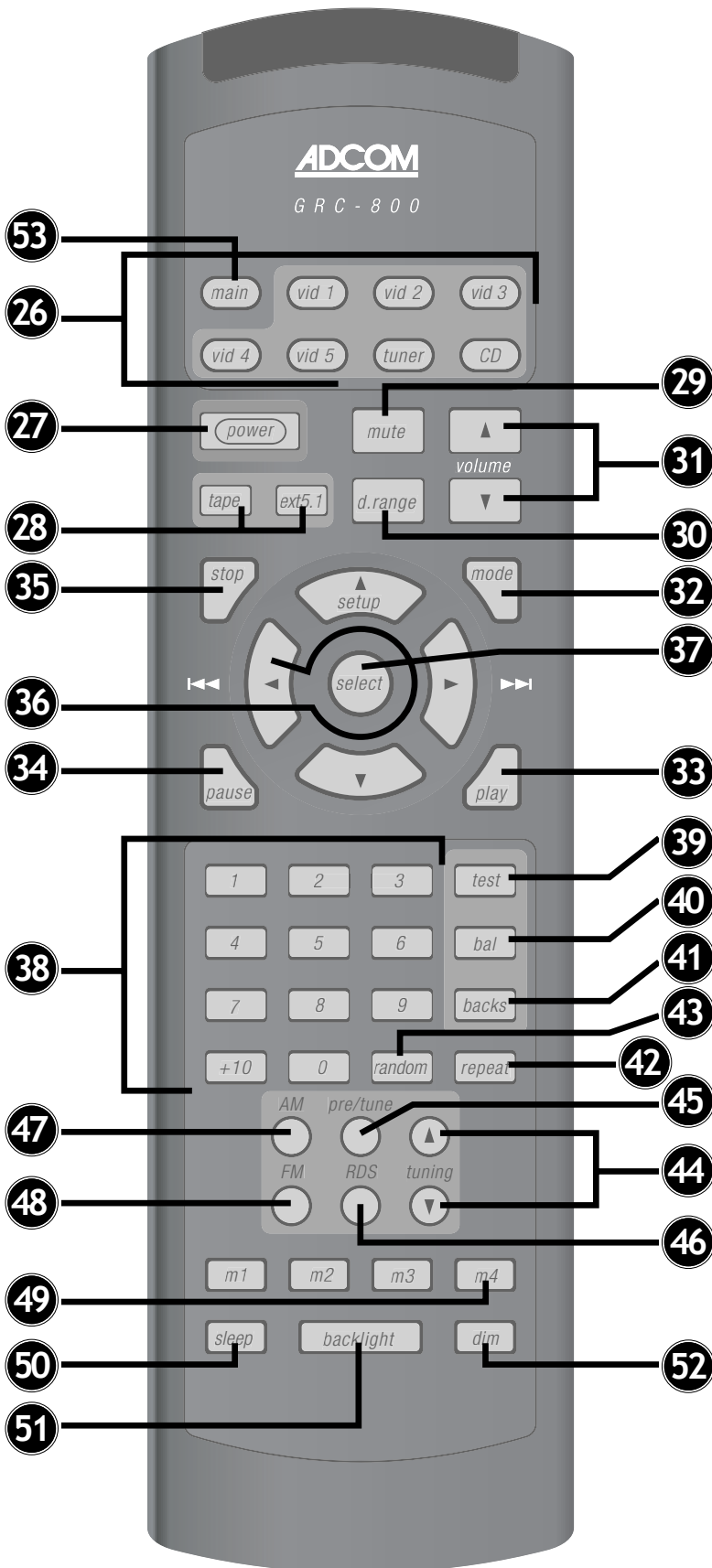

- [26] Source selectors
- [27] Power button
- [28] Input selectors
- [29] Mute button
- [30] d. range [dynamic range]
- [31] Volume Up/Down buttons
- [32] Mode button
- [33] Play button
- [34] Pause button
- [35] Stop button
- [36] Arrow buttons
- [37] Select button
- [38] Direct Access Keypad
- [39] Test button
- [40] Bal (balance check)
- [41] Backs button
- [42] Repeat button
- [43] Random button
- [44] Tuning Up/Down buttons
- [45] Pre/Tune button
- [46] RDS button
- [47] AM button
- [48] FM button
- [49] M1, M2, M3, M4 [Macro Keys]
- [50] Sleep button
- [51] Backlight button
- [52] Dim button
- [53] Main button

2.1 GRC-800 Overview

The GRC-800 remote control is a learning remote control that is capable of saving commands for all remote controls in your home theater system. In this way, you may eliminate the confusion of using multiple remotes. Although such power comes with some added complexity, the complexity is minimal and with some repetition will become second nature.

Eight Source Select Buttons

The single most important aspect to master about the GRC-800 remote control is the function of the eight source select buttons at the top of the remote. These are the buttons labeled [53] and [26] in the figure on the opposite page. Each of these buttons cause two things to happen when used. First, they select the corresponding input on the GTP-860II. Second, THESE KEYS REMAP ALL OF THE OTHER BUTTONS ON THE REMOTE CONTROL. You can think of each of these buttons as having a page of commands associated with it. Some buttons, such as volume up and down, are pre programmed to operate the GTP-860II for each source. These buttons can be "written over" if you like, but default to GTP-860II operations for your convenience.

Most of the GTP-860II remote commands are saved under the main remote page. Whenever you desire to control the GTP-860II via remote, you must first ensure the main page is active. As an example, press [53] main on the remote control. Now, press the dim button. If your GTP-860II is on, the brightness of the front panel display changes. Notice also that the main button on your remote illuminates. This serves as a reminder that the main remote page is currently active. Now press the CD button and then the play button. Notice now that the CD source button lights. The CD remote page is now active. If you have an ADCOM CD player, this command will cause an idle CD to play.

Now, press the dim button again. You should note that CD button does not light. The dim command is not pre programmed in the CD remote page. If your GTP-860II is on you will also notice the display does not respond to this command. Press the [53] main button again to reenter the main remote page. The dim button will now again change the GTP-860II display.

The button description that follows distinguishes the function of each button dependent on the page the remote is in. The remote is shipped from the factory with ADCOM commands saved under the main, tuner, and CD pages, and with important GTP-860II functions such as volume saved under each page.

The ADCOM universal remote controller is preset to operate all GTP-860II functions (MAIN and TUNER device mode) and most GCD-700/750 CD functions (CD device mode).

Alkaline batteries are recommended for maximum operating life. Four AAA (R 03) batteries should be fitted in the battery compartment at the rear of the remote control. When replacing batteries, check that they have been put in correctly, as indicated on the base of the battery compartment.

Remote Features

[26] Source Selectors (vid 1, vid 2, vid 3, vid 4, vid 5, tuner, CD):

These buttons serve two functions.

- First, they switch inputs on the GTP-860II so you can hear the source you've just selected.
- Second (and even more important), they can change the functions of all the other buttons on the remote controller. In other words, if you first push the CD device selector, the remote's play button generates a command code for your DVD player. If you then press the vid 5 device selector, the same play button would send a different command code

that might, for example, start your mini-disc player. (Of course, this all depends on how you programmed the remote in the first place. This will be covered shortly.)

[27] Power Button

In all modes, this is pre programmed to turn the GTP-860II on and off.

[28] Input Selector

In main mode, these are similar to the source selectors described above but they switch only GTP-860II inputs. They DO NOT automatically change the functions of other remote buttons.

[29] Mute Button

In all modes, this button is pre programmed to mute outputs of device. Mute does not affect recordings made using the Tape outputs but will affect the signal going to the Preamp Outputs. When the unit is in mute mode, any adjustment of the Volume Control on the front panel [4] will release the muting, i.e. the original volume level will be resumed.

[30] Dynamic Range

In main mode, this button is pre programmed to adjust dynamic range of Dolby Digital encoded sources.

The d. range button, which can be used only in combination with a Dolby Digital source, incrementally reduces the audio track's dynamic range in four steps (100%, 75%, 50% and 25%) to allow for comfortable listening under a variety of conditions. The normal or default position is 100%. To adjust the dynamic range, each consecutive press of the d. range button will reduce the value in 25% increments, as shown in the alphanumeric display section.

Although we usually prefer to reproduce a source's full dynamic range (the difference between very loud and very soft sounds), it may occasionally be desirable to reduce the dynamic range. For example, when playing a movie late at night, loud

explosions might wake sleeping family members. Simply turning the volume control down would probably make a whisper in the next scene inaudible. The d. range button solves this dilemma by progressively lowering the volume of loud peaks while increasing the level of softer sounds.

[31] Volume Up/Down

In all modes, these buttons change the master volume setting of the GTP-860II. In all modes except main, they can be reprogrammed with new commands. The Volume control does not affect recordings made using the Tape and Video, or Tape, Video 3 and Video 4 outputs but will affect the signal going to the Preamp output.

[32] Mode Button

In main mode, this is pre programmed to cycle through the surround modes of the GTP-860II. Pressing repeatedly will cycle through Pro Logic, Hall, and Stereo, when available. Refer to the Surround Mode description [8] for more information.

[33] Play Button

In CD mode, it is pre programmed for play with an ADCOM CD player.

[34] Pause Button

In CD mode, it is pre programmed to pause an ADCOM CD player.

[35] Stop Button

In CD mode, it is pre programmed to stop an ADCOM CD player.

[36] Arrow Buttons

The arrow buttons allow navigation throughout the GTP-860II OSD (On Screen Display) menus (as well as the menus of other devices, once the commands are learned). Please refer to section 3.1 for further explanations on the OSD.

Left arrow: In main mode, this is pre programmed to step through the various choices you might wish to select

while a menu item is highlighted.

In CD mode, it is pre programmed for audible reverse scan with an ADCOM CD player.

Up arrow/Setup: In main mode, this is pre programmed to enter the OSD menu system, as well as scroll up to the next choice on a menu screen.

Right arrow: In main mode, this is pre programmed to step through the various choices you might wish to select while a menu item is highlighted.

In CD mode, it is pre programmed for audible forward scan with an ADCOM CD player.

Down arrow: In main mode, this is pre programmed to scroll down to the next choice on a menu screen.

[37] Select Button

In main mode, this is pre programmed to enter a selection chosen via the menu system.

[38] Direct Access Keys

(buttons "1" through "10," and "+10"): In CD mode, buttons are pre programmed as track access commands for the ADCOM CD player.

[39] Test Button

Pressing the test button engages the test signal generator. The test signal cycles through the activated channels automatically with 3-second intervals from Front Left, Center, Front Right, Rear Right, Back Right, Back Left, Rear Left, to Subwoofer in continuous cycles. Press the test button again to turn off the test signal. You can make adjustments to channel balance with the test tone generator using the Channel Test section of the On Screen Display setup menus.

[40] Bal (balance) Button

In main mode, this button is pre programmed to initiate balance check procedure. Even when the GTP-860II

is correctly set-up, it may sometimes be desirable to make minor adjustments to suit the material you are listening to. Pressing the bal button allows for direct adjustment of all active channels. Use the up and down arrow buttons to select the channel you wish to adjust and the left and right arrows to modify the level. Both the front panel display and the OSD show the current status of adjustments. Press the Bal button a second time to exit this function, the new levels will automatically be saved.

[41] Backs Button

In all modes, this button is pre programmed to toggle on and off the Surround Back speakers.

[42] Repeat Button

In CD mode, this button is pre programmed as "repeat" command for ADCOM CD player.

[43] Random Button

In CD mode, this button is pre programmed as "random" command for ADCOM CD player.

[44] Tuning Up/Down

In tuner mode, these buttons are pre programmed to scan up or down the GTP-860II's AM or FM band.

[45] Pre/Tune Button

In main and tuner modes, this button toggles between manual tuning and preset station functions for the tuning up and down buttons [43].

[46] RDS Button

This button selects the type of RDS information that will be displayed when it is available from the currently selected radio station. The PTY mode will indicate program material type such as jazz or rock or classical. The call mode will usually display the call letters of the station (WXYZ), but may also include additional information about the current program material.

[47] AM Button

In main and tuner mode, buttons are pre programmed to select the AM band.

[48] FM Button

In main and tuner mode, buttons are pre programmed to select the FM band.

[49] M1, M2, M3, M4 (Macro Keys)

These buttons are programmable for use with any source.

[50] Sleep Button

Press sleep to make the GTP-860II

automatically switch off after a pre-set number of minutes. Pressing the sleep button once will set the sleep time to 90 minutes, after which the GTP-860II will automatically switch off into Standby mode. Sleep mode is shown on the Display Panel. To adjust the Sleep Delay, press the sleep button, each consecutive press will reduce the sleep time in 30-minute increments, as shown in the Display Panel. To cancel the sleep mode, continue pressing the sleep button until the sleep time returns to 0 minutes. Pressing the power on the front panel [1] or Stand-By button will also cancel the sleep mode.

[51] Backlight Button

No programming capabilities. This

button backlights all keys for eight (8) seconds when pressed.

[52] Dim Button

In main mode, button is pre programmed to dim GTP-860II's information display.

[53] Main Button

In all modes, button provides access to the GTP-860II. For instance, to turn on the test tone generator first push [53] the main button, then push [39] the test button.

2.2 Remote Function Table

This table supplements the information you've just read. Use it to quickly review button functions. The controller's capabilities are extensive and may be somewhat intimidating at first. However, you will soon find that its logical button arrangement and programming capabilities will greatly increase your enjoyment as you discover the ease with which you can operate your entire system from just one remote!

Look down the left-hand column until you see the button you want to learn about. Then look under MAIN to see if it is pre programmed for a GTP-860II function, under CD to see what CD commands are pre programmed, and under TUNER to see all pre programmed tuning functions.

NOTES: Direct sunlight or very bright ambient lighting may affect the operating range and angle for the remote control handset.

The infrared remote control command receiver, located to the right of the Power button, receives commands from the remote control. There must be a clear line-of-sight path from the remote control to this window; if that path is obstructed, the remote control may not work.

BUTTONS	Main	CD	Tuner	All Others
MAIN	Selects Main	Selects Main	Selects Main	Selects Main
VID 1	Selects Video 1	Selects Video 1	Selects Video 1	Selects Video 1
VID 2	Selects Video 2	Selects Video 2	Selects Video 2	Selects Video 2
VID 3	Selects Video 3	Selects Video 3	Selects Video 3	Selects Video 3
VID 4	Selects Video 4	Selects Video 4	Selects Video 4	Selects Video 4
VID 5	Selects Video 5	Selects Video 5	Selects Video 5	Selects Video 5
TUNER	Selects Tuner	Selects Tuner	Selects Tuner	Selects Tuner
CD	Selects CD	Selects CD	Selects CD	Selects CD
POWER	Power On/Off	Power On/Off	Power On/Off	Power On/Off
MUTE	Mute Volume	Mute Volume	Mute Volume	Mute Volume
VOLUME UP	Master Volume Up	Master Volume Up	Master Volume Up	Master Volume Up
VOLUME DOWN	Master Volume Down	Master Volume Down	Master Volume Down	Master Volume Down
TAPE	Selects Tape	Programmable	Programmable	Programmable
EXT 5.1	Selects Ext 5.1	Programmable	Programmable	Programmable
D. RANGE	Dynamic Range adjust	Programmable	Programmable	Programmable
STOP	Not programmable	Stop CD	Programmable	Programmable
MODE	Surround Mode Select	Surround Mode Select	Surround Mode Select	Surround Mode Select
PAUSE	Not programmable	Pause CD	Programmable	Programmable
PLAY	Not programmable	Play CD	Programmable	Programmable
SETUP/UP	Not programmable	Programmable	Programmable	Programmable
RIGHT	OSD Right Select	Skip Ahead	Programmable	Programmable
DOWN	OSD Scroll Down	Programmable	Programmable	Programmable

continued on opposite page.

BUTTONS	Main	CD	Tuner	All Others
LEFT	OSD Left Select	Skip Back	Programmable	Programmable
SELECT	OSD "Enter" Select	Programmable	Programmable	Programmable
1	Not programmable	Track 1	Preset 1	Programmable
2	Not programmable	Track 2	Preset 2	Programmable
3	Not programmable	Track 3	Preset 3	Programmable
4	Not programmable	Track 4	Preset 4	Programmable
5	Not programmable	Track 5	Preset 5	Programmable
6	Not programmable	Track 6	Preset 6	Programmable
7	Not programmable	Track 7	Preset 7	Programmable
8	Not programmable	Track 8	Programmable	Programmable
9	Not programmable	Track 9	Programmable	Programmable
0	Not programmable	Track 10	Programmable	Programmable
+10	Not programmable	+10	Programmable	Programmable
TEST	Test Tone On/Off	Programmable	Programmable	Programmable
BAL	Selects Channel Trims	Programmable	Programmable	Programmable
BACKS	Surr Backs On/Off	Surr Backs On/Off	Surr Backs On/Off	Surr Backs On/Off
REPEAT	Not programmable	Repeat Current Track	Programmable	Programmable
RANDOM	Not programmable	Random Play	Programmable	Programmable
AM	Not programmable	Programmable	Selects AM	Programmable
FM	Not programmable	Programmable	Selects FM	Programmable
PRE/TUNE	Selects Presets/Tuner	Programmable	Selects Tune/Preset	Programmable
RDS	RDS Tuning	Programmable	RDS Tuning	Programmable
TUNING UP	Tuning Up	Programmable	Tuning UP	Programmable
TUNING DOWN	Tuning Down	Programmable	Tuning Down	Programmable
M1	For Macro Use	For Macro Use	For Macro Use	For Macro Use
M2	For Macro Use	For Macro Use	For Macro Use	For Macro Use
M3	For Macro Use	For Macro Use	For Macro Use	For Macro Use
M4	For Macro Use	For Macro Use	For Macro Use	For Macro Use
SLEEP	Sleep	Sleep	Sleep	Sleep
BLACKLIGHT	Backlights All Buttons	Backlights All Buttons	Backlights All Buttons	Backlights All Buttons
DIM	Dims Display	Programmable	Programmable	Programmable

2.3 Programming Your ADCOM GRC-800 Remote

The ADCOM universal remote controller operates eight different audio/video components. As you've already seen, it's pre programmed to control ADCOM's GTP-860II Preamp/Tuner and the GCD-700/750 CD players. In addition, it has seven "component memory banks" available so you can program the remote to learn commands for your DVD player, satellite box, laser disc player, VCR, etc. This lets you use one remote controller for your entire system.

Using Pre programmed Commands

Using the remote controller's pre programmed commands is simple. For most GTP-860II functions (volume up/down, changing surround modes, etc.), follow these easy steps.

1. Press the main source selector button. This tells the remote that you want to use GTP-860II pre programmed commands. The main button will flash red to tell you it understands.

2. Press the appropriate function button (volume up, volume down, etc.) If you've selected a button that actually triggers a GTP-860II command, the main button will again flash red to confirm your choice. If the main button does not flash, you've selected a function button that isn't pre programmed.

For tuner functions (changing stations, etc.):

1. Press the tuner source selector button. It will flash red.
2. Press the tuning up (or tuning down) function button to change stations. The tuner source selector will flash red to confirm that the function button you've selected actually triggers a command. (Again, use the table to see which buttons are pre programmed.)

Press the CD source selector first to access pre programmed commands for

ADCOM CD players.

NOTE: You can program new commands over the pre programmed commands in tuner and CD if you wish. However, you cannot program any buttons, even those unprogrammed with GTP-860II command codes, while you're in main mode. This safety feature assures you that you will always be able to fully enjoy the GTP-860II's capabilities.

Programming Your Own Commands

You can supplement pre programmed commands with commands to operate other components. Before you begin to follow these steps, note the status LED located at the top left corner just above the remote's button panel: It will flash red, orange, or green to signal particular functions as you enter new commands into your ADCOM remote.

Begin by deciding which source component's commands you will be transferring to the ADCOM remote. Then press the appropriate source selector button. For example, if you're teaching your ADCOM remote commands for your Video 1 source, press the vid 1 source selector first. You can "teach" your remote new commands for any function button (except backlight) after you've selected vid 1, vid 2, vid 3, vid 4, vid 5, tuner, or CD.

1. Place the source component's remote "head to head" with the ADCOM remote. They should be in line with each other about 2 to 3 inches apart.
2. Press the ADCOM remote's appropriate source selector and select buttons simultaneously. Hold both buttons until the status LED turns orange and the source selector button glows red. Both indicators should remain lit.
3. Decide which function button on the ADCOM remote you want to learn a new command. Press it. The orange status LED will begin to flash and the source selector LED will go out.

4. Find the corresponding button on the source component's remote. Press and hold it until the status LED on the ADCOM remote flashes green once and remains green until the button on the source remote is released. Once the button on the source remote is released, the status LED will start flashing orange again.

5. Verify that the ADCOM remote has learned the new command by pressing and holding the same button on the source remote. The ADCOM remote's status LED should flash green twice and then go back to steady orange. This indicates successful programming. Release the button on the source remote.

Repeat Steps 3 through 5 for any other commands you want to teach your ADCOM remote for that source component.

Save the commands you've just programmed into the ADCOM remote by pressing and holding the appropriate source selector and select buttons simultaneously. Hold until the status LED and source selector LED flash twice and then go out. Repeat these steps for any other source commands you wish to program.

Deleting (Clearing) Individual Programmed Commands

1. Press the ADCOM remote's source selector and select buttons simultaneously and hold until the orange status LED and the source selector button glow steadily.
2. Press the function button you wish to clear. The status LED will flash continuously.
3. Press the backlight button. The status LED will then flash green twice and then revert to steady orange. The source selector button will continue to glow.

Repeat steps 2 and 3 for any other command you wish to delete for the same source component.

4. Exit “delete mode” by pressing and holding the source selector and select buttons simultaneously. The orange status LED and the source selector button will turn off.

Deleting All The Programmed

Commands for One Source Component

1. Press the ADCOM remote’s source selector and select buttons simultaneously and hold until the orange Status LED and the source selector button turn on and remain lit.

2. Press and hold down the backlight button. The red Status LED and the Device button will flash five times, the Status LED will then flash green twice and turn to a constant orange, indicating that all the learned information for the device mode selected has been erased.

3. To exit this feature, press and hold the ADCOM remote’s source selector and select buttons simultaneously. The orange status LED and the source selector button will flash twice and then turn off.

Deleting All The Programmed Commands for Every Source Comp.

NOTE: This procedure erases every programmed command accessed under the selected vid 1, vid 2, vid 3, vid 4, vid 5, tuner, and CD input selectors. Make sure you really want to do this before following the step below.

1. Press and hold the VID 5 input selector and the backlight button simultaneously. The red status LED will flash twelve times. The status LED will then flash green once, followed by a single orange pulse.

All LEDs will then turn off, indicating that every learned command in the ADCOM remote has been erased.

Macro Commands

“Macro” commands are simply a series of individual commands initiated by pushing just one button.

The ADCOM remote can learn up to 10 individual commands and store them as a single macro.

There are five “macro initiator” buttons on the ADCOM remote: power, m1, m2, m3, and m4. Each “macro initiator” can store and transmit either of two complete macros, depending on which source selector is active when you push it.

For macro programming purposes, think of the source selectors as being in two groups: main, vid1, vid 2, and vid 3 in Group 1; vid 4, vid 5, tuner, and CD in Group 2. When you program a “Group 1” macro, you will start by pushing the main source selector. After you’ve completed and memorized that macro command series, you can initiate it whenever you’re in main, vid 1, vid 2, or vid 3 modes. Similarly, you will program “Group 2” macros by pushing vid 4 first and can use them whenever the vid 4, vid 5, tuner, or CD inputs are active.

For example, if the m1 button is programmed in Group 1 mode to turn on the TV, turn on the audio receiver, turn on the VCR, and then turn on the satellite receiver, it will perform the same series of commands whenever the m1 button is pressed IF main, vid 1, vid 2, or vid 3 sources are selected at the time you select that macro. If you’ve programmed a Group 2 macro, it will send out an identical command sequence whenever vid 4, vid 5, tuner, or CD inputs are selected.

2.4 Programming Macro Initiator Buttons

1. Press either the Group 1 or Group 2 source selector button (main or vid 4 respectively) and the mute button simultaneously. Hold both buttons until the red status LED and the input selector button remain lighted.

2. Press the macro initiator button (power, m1, m2, m3 or m4) you wish to program.

3. Select and press up to 10 buttons you wish to store in the macro. Both source selector and function buttons count as individual commands. Remember that each macro can hold only up to 10 individual commands.

4. Press the tuning up button to save the macro. The red status LED and input selector button will blink twice to confirm programming and then turn off.

Please note:

- To add a power (on/off) command to the macro, use the mute button in place of the power button.
- The tuning up/down buttons cannot be used in a macro sequence.

Deleting Macro Initiator Buttons:

1. Press either the Group 1 or Group 2 source selector button (main or vid 4 respectively) and the mute button simultaneously. Hold both buttons until the red status LED and the input selector button remain lighted.

2. Press the macro initiator button (power, m1, m2, m3 or m4) you wish to delete.

3. Press the tuning up button. The red status LED and input selector button will blink twice to confirm deletion of the macro.

Function and Data list for GTP-860 II (ADCOM) Discrete (Direct Access) Custom Code for Installers

1AE8h: Custom Code(B)

Custom Code(B): 0101 1000 0001 0111 LSB on left

Code:NEC

Function	Data(B)	D	Function	Data(B)	D
MAIN POWER ON	0010 1010	84	Surround Backs ON	1000 1111	143
MAIN POWER OFF	1010 1010	85	Surround Backs OFF	1100 1100	204
DOLBY PRO LOGIC	0111 0000	14	Mute ON	0110 0001	86
SYMPHONY HALL	1111 0000	15	Mute OFF	1110 0001	87
2 CHANNEL STEREO	1111 0010	79	FM mode - mono	0010 1000	20
5 CHANNEL STEREO	0111 0010	78	FM mode - stereo	1010 1000	21
DOLBY PL II CINEMA	0011 1010	92			
DOLBY PL II MUSIC	1011 1010	93	Tuner mode - direct	1101 0001	139
DOLBY PL II PANORAM	0111 1010	94	Tuner mode - preset	0001 0011	200
			Tuner preset Memory	1101 0011	203
			System Reset 1 (NTSC)	0011 1001	156
Dynamic Range Norm.	0100 0010	66	System Reset 2 (PAL)	1011 1001	157
Dynamic Range 75%	1100 0010	67	Video toggle NTSC/PAL	0111 1001	158
Dynamic Range 50%	0110 0010	70			
Dynamic Range 25%	1110 0010	71			
			AM stepping Freq. toggle 10kHz/9kHz	1111 1001	159
Center Trim +	0001 0000	8			
Center Trim -	1001 0000	9			
Rear Left Trim +	0101 0000	10			
Rear Left Trim -	1101 0000	11			
Rear Right Trim +	0001 0010	72	Test VFD	0011 1011	220
Rear Right Trim -	1001 0010	73			
Subwoofer Trim +	0101 0010	74	Show firmware version	1011 1011	221
Subwoofer Trim -	1101 0010	75			
Back Left Trim +	0011 1000	28			
Back Left Trim -	1011 1000	29			
Back Right Trim +	0111 1000	30			
Back Right Trim -	1111 1000	31			

Suggested Speaker Locations

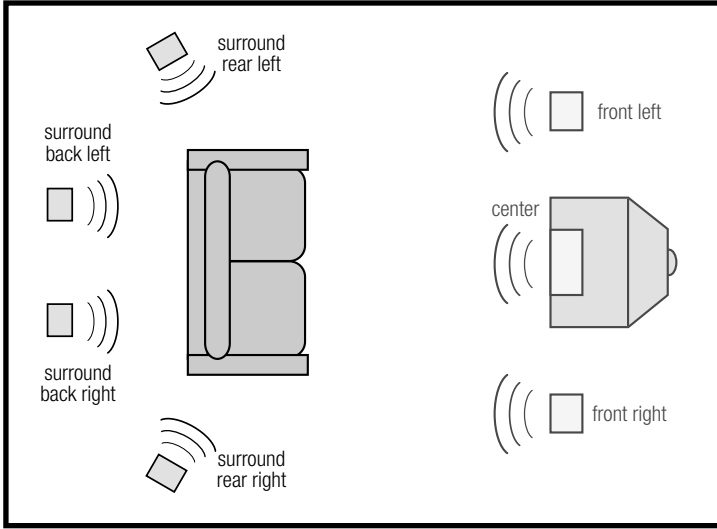

This is the preferred speaker setting if you are using surround backs.

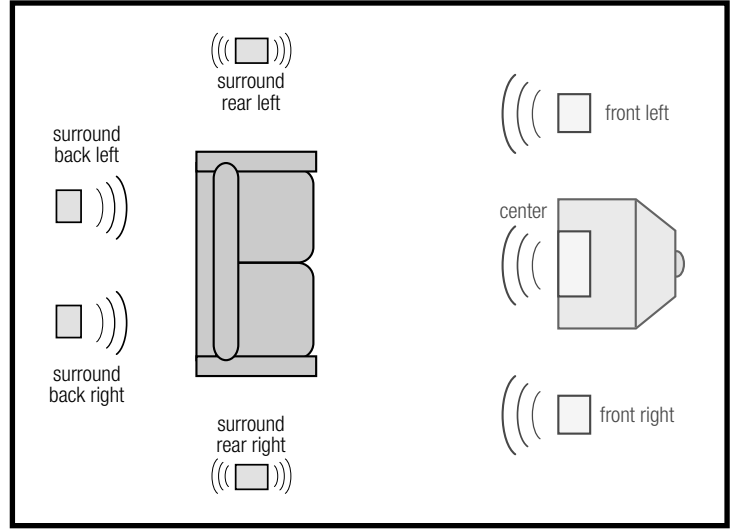

This speaker setting is preferred if you are using dipoles for your surround rears.

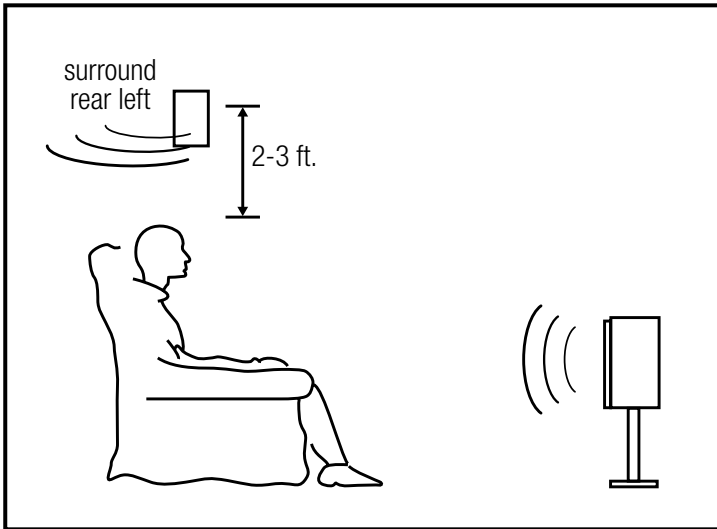

This speaker setting is preferred if you are not using surround backs.

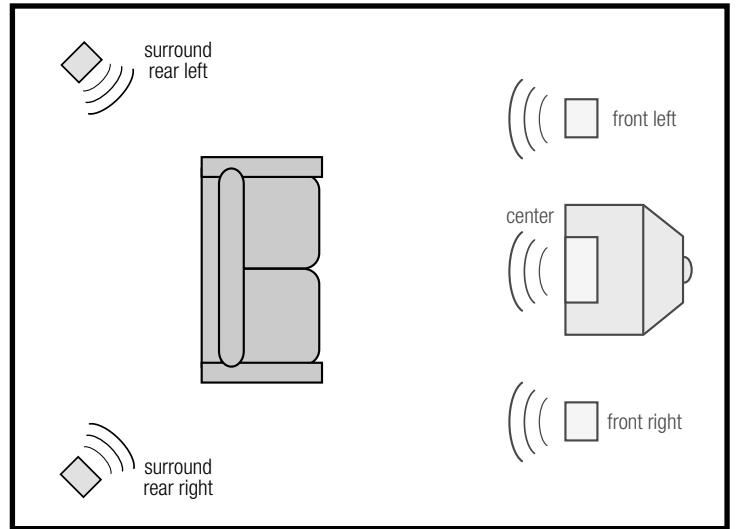

This speaker setting is preferred if you are not using surround backs.

3.0 Operation & Setup

After connecting your home theater, you may elect to configure the GTP-860II to the specific speaker arrangement and dimensions of your system. The procedures described in this section demonstrate how to use the GTP-860II's on-screen display to enter this information. Once complete, the GTP-860II stores this information so that these tasks need only be repeated if speakers are changed or substantially repositioned. In addition to speaker setup, many other operations can be configured using the on-screen display system.

3.1 On-Screen Display

The GTP-860II is equipped with an elaborate On-Screen Display (OSD) facility. As the OSD is an essential tool to set up the various parameters for surround sound correctly it is recommended that you connect your monitor or television to the GTP-860II. The OSD signal is only available on the S-Video and composite video outputs, not on the component video output.

The OSD is engaged by pressing main and then the setup button on the remote control. The SETUP Menu will appear as below:

Use the cursor buttons [36] on the

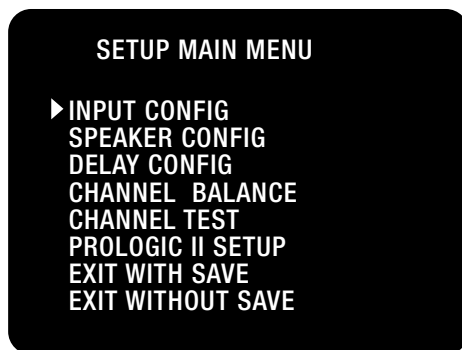

remote control to navigate between the available options. The up and down arrow buttons are used to navigate and select an option. The left or right arrow buttons are used to change settings, and select [37] is used to choose the desired option.

3.2 Speaker Config

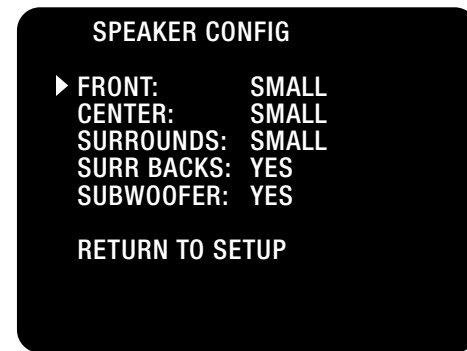

In order to optimize the performance of your system, the GTP-860 II can be configured specifically for the speakers in your system. Information about each of your speakers allows the GTP860 II to tailor the audio output for best sound. The setup procedure breaks your speaker system into five groups: front, center, surrounds, surround backs and subwoofer. There are a few options for each group.

Front: small or large
Center: small, large or none
Surrounds: small, large or none
Surr backs: yes or no
Subwoofer: yes or no

The large mode is used when the speaker is full range and capable of reproducing the entire audible frequency spectrum from 20Hz to 20kHz. The small mode is used when the speaker is not capable of reproducing the deepest bass portion of the audio frequency 20Hz to 80Hz. When a speaker is set to small, the low frequencies intended for that speaker are redirected either to the front speakers or the subwoofer. The front speakers can only be set to small if you are also using a subwoofer.

If you are not using one of the speakers in a group select "none" and the information for that channel will be redirected to the speakers you are using.

For best results, you should consider using a center speaker. Ideally it should be the same type as the left

and right speakers. Using a separate center channel speaker will allow the dialogue to cut through even the biggest sound effects and musical scores. Having the sound spread across three front speakers also stabilizes the stereo image, making the usable listening area much bigger. If you do not wish to use a center speaker select "no" for the center speaker.

Installing surround speakers will greatly enhance the surround experience as these speakers add considerably to the overall sense of spaciousness in the playback system. It is best to choose loudspeakers which are similar in power handling and performance capability to those of the front channels. If you are using only one pair of surround speakers, make sure to connect them to the surround rear outputs. If you choose to install the surround back speakers, locate them behind your listening position, and connect them to the surround back outputs. Surround back channels add to the spaciousness and coherence of the sound field, but the surround rear channels must be present for the desired effect. If you are using surround back speakers select the surr backs option to yes. Note that the surround back speakers will track the surround rear speakers with regard to small/large settings.

Many film sound tracks rely heavily on very low frequency sound effects which are difficult for normal or smaller hi-fi speakers to reproduce. To faithfully reproduce these low frequencies you can use a specially designed low frequency loudspeaker with its own built-in amplifier ("powered subwoofer"). Because it is difficult to hear which direction very low frequencies come from, you only normally need one subwoofer and this can be placed virtually anywhere in the room. Dolby Digital uses a dedicated low frequency effects (LFE) channel. If a subwoofer has been selected, the LFE channel will be fed to the subwoofer output.

3.3 Delay Config

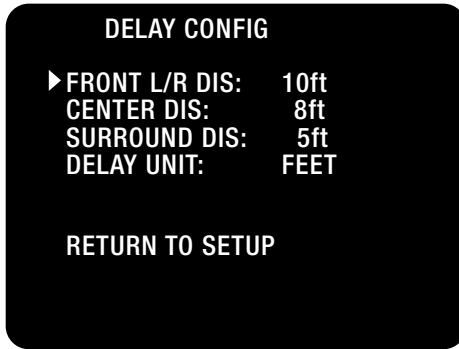

For the best surround sound performance it is important that sound from all speakers reach the listener's ears at the same time. Because the surround/rear speakers are usually closer to the listener than the front speakers, there is a tendency for the ear to localize sounds to the rear, because the ear gives precedence to the sounds that arrive at the head first. Similarly, the center speaker is often closer to the listener than the front left and right speakers. To compensate for this, the GTP-860II can slightly delay the audio sent to the center and rear (closer) speakers. In this way, when playing Dolby Digital or Dolby Pro Logic sound tracks, the sound from all speakers arrives uniformly at the listening position as intended by the film's producer.

To configure the channel delays, measure or estimate the distance for each of the speakers to the main listening location. The GTP-860II will automatically configure the correct settings for processing. Note, the information can be input in either feet or meters by selecting the desired unit in the DELAY UNIT field.

3.4 Channel Balance and Channel Test

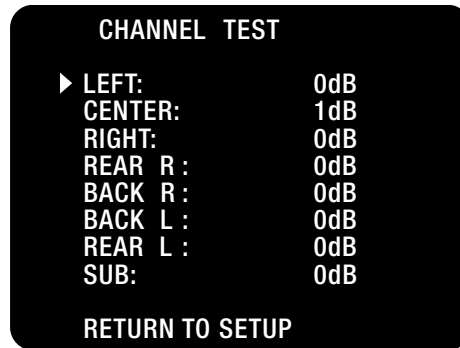

The output levels of each of the speakers connected to the GTP-860II may need to be adjusted so that there is an even balance of sound from all the speakers in the system. If, for instance, the relative volume level of the front left and right speakers is too high relative to the center speaker, dialog may be difficult to understand. If on the other hand, the center speaker is set too loud, all sound will seem to be coming from only the center channel speaker.

The best method for setting the channel balance is to use a sound pressure level meter (available from Radio Shack) and the built-in test tone generator in the GTP-860II. To access the test tone, navigate to the channel test page on the OSD. Be careful to lower the master volume level first because the test tone signal can be very loud. The noise signal will be heard from the speaker that is currently selected. By navigating through the speakers and monitoring the sound level on the meter, the level adjust for each speaker can be determined. It is best to keep the sound level meter at the most central listening seat for these adjustments. Note that the tone color of the noise coming from the subwoofer will be different than from the other speakers; this is due to the limited frequency response of a subwoofer. Due to limitations of most sound-level meters it is best to adjust the subwoofer level while listening to music.

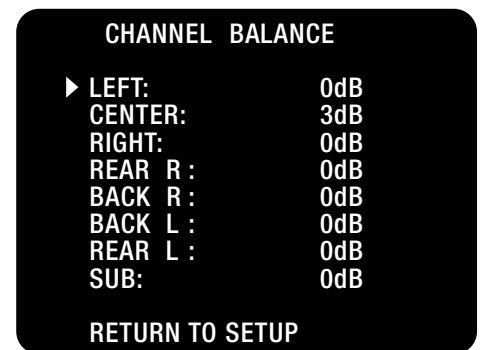

If you wish to adjust the channel levels without using the test tone, then select the Channel Balance menu or push the bal [40] button on the remote. Note that only speakers that you selected in the speaker configuration menu will be available.

3.5 Input Config

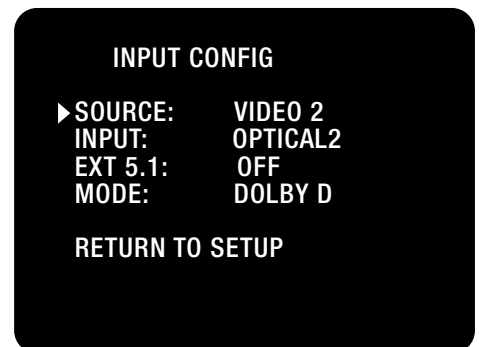

The input configuration menu allows you to configure the audio input for each of the source buttons and to set a default surround mode for each source.

The source selection allows you to select which of the input buttons you wish to configure.

The input section is used to determine what audio input the source will use. The options are the analog stereo input associated with the source or to override the analog input and use one of the six digital inputs.

The ext 5.1 section allows you to select the 6 channel audio input usually associated with a DVD audio or SACD player for the source button you are configuring.

The mode option sets the default surround mode to be used with each source. The options are DOLBY DIGITAL, DTS, PRO LOGIC II-C/M/P, HALL, STEREO, and 5 CH STEREO. The available choices in each of the fields can be selected with the left or right arrow buttons on the remote; confirm the choice with the select button.

3.6 ProLogic II Setup

Dolby ProLogic II is a surround mode that can be used to generate surround sound from stereo program material. The settings below can be

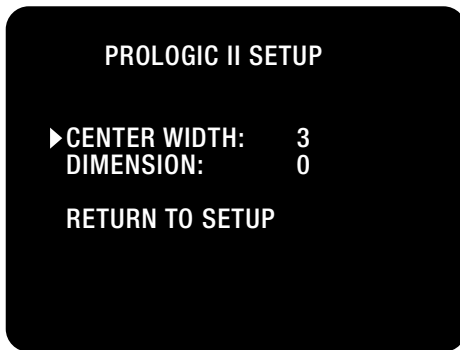

used to optimize the surround sound listening experience when you are using ProLogic II.

DIMENSION = This parameter is used when listening in ProLogic II Music mode, it changes the level balance from front speakers to back speakers, much the same way the fader adjust works in some car audio systems. The value can be varied from -3 (more sound level from the rear) to 3 (more sound level from the front).

CENTER WIDTH = This adjustment is used when listening to ProLogic II music mode. It changes the amount of sound coming out of the center speaker. Adjust this parameter for best over all imaging between the front left/right and center speaker. As the value is increased, the apparent image width of the sound stage will increase.

3.7 Other Setup Functions

The GTP-860 II also has certain functions that can be accessed by using multiple front panel buttons pressed simultaneously.

Reset 1: Restore factory default settings and NTSC video = FM/AM button + video 1 button

Reset 2: Restore factory default settings and Pal video = FM/AM button + video 2

Video Mode switch (system interchange): Change unit between NTSC and Pal video = FM/AM button + CD button

Frequency interchange: Changes the unit AM stepping frequency between US (10kHz) and Europe (9kHz) = FM/AM button + tape monitor button

VFD segment test: lights up all segments of the front panel display = memory button + AM button + video 4 button. Press any key to exit test mode.

Display software version: shows current version of software on the front panel display = memory button + FM button + video 5 button. Press any key to exit.

Program EEPROM: Programs and restores the system memory to factory preset condition = memory button + CD button + surround mode button. Press any key when programming is complete.

SYMPTOM	POSSIBLE REASON	POSSIBLE SOLUTION
No sound	<ul style="list-style-type: none"> • Power AC lead unplugged or power not switched on • Tape Monitor selected • Mute on • Power Amplifier not on 	<ul style="list-style-type: none"> • Check if AC lead is plugged in and power switched on • De-select Tape Monitor mode • Switch off Mute • Turn on the Power Amplifier
No sound on one channel	<ul style="list-style-type: none"> • Speaker not properly connected or damaged. • Input lead disconnected or damaged • In Setup "OFF" for surround speaker selected 	<ul style="list-style-type: none"> • Check connections and speakers • Check leads and connections • Select appropriate Surround mode (large or small)
No sound on surround channels	<ul style="list-style-type: none"> • No surround mode selected • Mono sound source • Speakers not properly connected • Surround volume level too low 	<ul style="list-style-type: none"> • Select a Surround Mode • Test system with Stereo or Dolby Surround material • Check speakers and connections • Increase surround volume level
No sound on center channel	<ul style="list-style-type: none"> • In Setup "OFF" for center speaker selected • Speaker not connected properly • Center volume level set too low 	<ul style="list-style-type: none"> • Select appropriate Center mode (large or small) • Check speaker and connection • Increase center volume level
"Dolby Digital" OR "DTS" auto-detection function does not work	<ul style="list-style-type: none"> • Source not connected using digital input • Bit Stream is PCM 	<ul style="list-style-type: none"> • Connect digital output of source to GTP-860II • Check source material
Weak bass/Diffuse stereo image	<ul style="list-style-type: none"> • Speakers wired out of phase 	<ul style="list-style-type: none"> • Check connections to all speakers in the system
Remote control handset not working	<ul style="list-style-type: none"> • Batteries dead, or incorrectly inserted • IR transmitter or receiver windows obstructed • IR receiver in direct sun or very bright ambient light 	<ul style="list-style-type: none"> • Check or replace batteries • Remove obstruction • Place unit away from direct sun, reduce amount of ambient light
No sound with tuner	<ul style="list-style-type: none"> • Antenna leads incorrectly connected • Station not selected or weak signal with FM Mute on. 	<ul style="list-style-type: none"> • Check antenna connections to preamplifier • Re-tune or switch off FM Mute
Noise, hiss on AM and FM	<ul style="list-style-type: none"> • Weak signal 	<ul style="list-style-type: none"> • Check station tuning. Adjust or replace antenna.
Distortion on FM	<ul style="list-style-type: none"> • Multi-path signals or interference from another station 	<ul style="list-style-type: none"> • Check station tuning. Adjust or replace antenna
Whistles or buzzes on FM & AM	<ul style="list-style-type: none"> • Interference from other electrical sources - computers, games consoles 	<ul style="list-style-type: none"> • Check station tuning. Switch off or move the source of the electrical noise
Whistles or buzzes on AM	<ul style="list-style-type: none"> • Interference from fluorescent lighting or electrical motor 	<ul style="list-style-type: none"> • Check station tuning. Adjust or replace AM antenna
No RDS name (PS)	<ul style="list-style-type: none"> • Station signal too weak. • Station not transmitting RDS data 	<ul style="list-style-type: none"> • Check station tuning. Adjust or replace antenna • No remedy

Troubleshooting

Use the troubleshooting notes above to solve common situations that don't require professional attention. If the steps stated in possible solution do not resolve your problem, then please contact your ADCOM dealer or call the ADCOM customer service department. Any problems not covered here should be brought to the attention of your ADCOM dealer or ADCOM customer service department.

A special note on "hum:" When there is a low-volume "hum" audible throughout your speakers, even with the main volume turned all the way down, you have a common phenomenon known as a "ground loop." A ground loop is basically a difference in ground voltages between two or more components which are connected electrically and which creates multiple current paths where there must only be one. This difference in potentials creates a 60Hz low-level sound (approximately a low A), that seems to "hum."

It can be caused by adding new components to your system, but that does not imply there is anything electrically wrong with any new component. With the advent of audio/video and home theater systems, the problem has become commonplace. Generally, the cause is the Cable-TV incoming signal line. This new incoming line may add an additional ground at a different potential to the AC line ground of your other equipment (refer to note 1 and 2, to troubleshoot a hum problem).

Note 1: Cable TV systems can sometimes contribute to ground loop problems which cause "hum." To determine if your cable system is the contributing factor, disconnect the Cable-TV incoming signal line (round, 75Ω) at the wall,

or the first component the cable is connected to (i.e. the cable box, or VCR). If the hum is no longer present, you must insert a "75Ω ground loop isolator" before reconnecting the line. You should check with your ADCOM dealer to obtain one. If the "75Ω ground loop isolator" works only partially or not at all, then please read note 2 to complete the troubleshooting procedure.

Note 2: Make sure that the power amplifier is at least 6" from processor or other equipment using microprocessors. Usually putting another component between them is sufficient to minimize the hum. If this does not reduce the hum, turn the system off and disconnect all Inputs from the amplifier. If the hum still persists, then your dealer or service center must examine the unit/system. If the hum disappears, try another set of RCA cables. Connect one RCA cable at a time to see if one specific cable is responsible. If any or all cables cause the hum to appear, then the unit should be evaluated for proper operation by your dealer or authorized service center. Please see our website or call us for a list of authorized service centers in your area.

Servicing

ADCOM has a technical service department to answer questions pertinent to the installation and operation of your unit. In the event of difficulty, please contact us for prompt advice. If your problem cannot be resolved through our combined efforts, we may refer you to an authorized repair agency, or authorize return of the unit to our factory. To aid us in directing you to a convenient service center, it would be helpful if you indicate which major city is accessible to your home.

Troubleshooting Tip

Your GTP-860II's circuitry is built around advanced microprocessors. The GTP-860II may exhibit occasional anomalies arising from AC line surges, etc. If you experience unexpected behavior, or if the GTP-860II "locks up" and does not respond to control input, reset it by turning the front power switch off. (Do not use the remote control's "power" button.) Wait 10 seconds and then turn the GTP-860II

This unit is manufactured under license from Dolby Laboratories Licensing Corporation. It is additionally licensed under one or more of the following patents: U.S. number 3,959,950, Canadian numbers 1,004,603 and 1,037,877. Dolby® Pro Logic®, and Dolby Digital® are registered trademarks of Dolby Laboratories Licensing Corporation.

Manufactured under license from Digital Theater Systems, Inc. US Patent Number 5,451,942 and other worldwide patents issued and pending. "DTS," "dts," "DTS Digital Surround," are trademarks of Digital Theater Systems, Inc. Copyright 1996 Digital Theater Systems, Inc. All Rights Reserve

Please address mail inquires to:

ADCOM Service

8541 East Anderson Drive

Scottsdale, Arizona 85255 USA

Phone, Fax or Email inquires to:

Voice: (480) 607-2277 or Fax: (480) 348-9876

Monday through Friday, 8:00 AM to 4:00 PM MST

Email: service@adcom.com

For fax inquires, please include a return fax number for the reply. When calling or writing about your ADCOM product, be sure to note and refer to its serial number as well as the date of purchase and the dealer from whom it was purchased. In any communications to us, please include a daytime phone number where we may reach you. In the event the unit must be returned to our factory for service, you will be instructed on the proper procedure when you call or write for a return authorization. **Under no circumstances should your unit be shipped to our factory without prior authorization, or packed in other than its original carton and fillers.**

If the original shipping carton and its fillers have been lost, discarded, or damaged, a duplicate carton may be obtained from our service department for a nominal charge.

Always ship prepaid via United Parcel Service (UPS) or other approved carrier. Do not ship via parcel post, since the packing was not designed to withstand rough parcel post handling. Improper shipment of the product will void your warranty coverage.

Warranty

ADCOM, a division of Klein Technology Group, LLC, makes the following limited warranties. These limited warranties extend to the original purchaser or any person receiving this product as a gift from the original purchaser and to no other purchaser or transferee. **There is no warranty provided by ADCOM for products purchased from unauthorized outlets or dealers or from previous owners.**

Limited Five Year Warranty (Home, Non-Commercial Use Only)

ADCOM warrants this product against defects in materials or workmanship for a period of five (5) years after the date of original retail purchase from an ADCOM authorized dealer. During this period, ADCOM will repair or replace a defective product or part, at our option, with a new or refurbished product or part without charge to you, as long as you follow the procedures listed below.

Limited Ninety (90) Day Warranty (Commercial Use Only)

ADCOM warrants this product against defects in materials or workmanship for a period of ninety (90) days after the date of original purchase from an ADCOM authorized dealer. During this period, ADCOM will repair or replace a defective product or part, at our option, with a new or refurbished product or part without charge to you, as long as you follow the procedures listed below.

All implied warranties, including implied warranties of merchantability and fitness for a particular purpose are limited in duration to the duration of the warranty period.

This warranty excludes all incidental and consequential damages, unless contravened by state law. This warranty gives you specific rights and you may have other rights which vary from state to state.

No person, agent, distributor, dealer, or company is authorized to change, modify or extend the terms of these warranties in any manner whatsoever.

Your Responsibilities

The above warranties are subject to the following conditions:

(1) You must retain and present your dated invoice or bill of sale to provide proof of original purchase from an ADCOM Authorized Dealer and coverage under the warranty period.

(2) You must notify us within ten (10) days after you discover a defective product or part.

(3) All warranty servicing of this product must be done by ADCOM or an authorized ADCOM Service Center.

(4) This warranty is only valid if this product has been purchased and used in the United States. Warranty coverage for products purchased and used outside of the United States is provided by local ADCOM authorized distributors.

(5) Charges by third parties for set-up, installation, adjustments, shipment, insurance, and other charges are not covered by this warranty.

(6) This warranty extends only to defects in material or workmanship as limited above and does not extend to any product or part which has been lost or discarded by you, or to damage to products or parts caused by misuse, accident, Acts of God such as lightning or fluctuations in electrical power, improper installation, improper maintenance or use in violation of instructions provided in this Owner's Manual, or to products which have been altered or modified. This warranty does not extend to products which have had the serial number removed, altered, defaced, or rendered illegible.

(7) Physically damaged products are not covered by this warranty and will be returned as received without repair.

GTP-860II Specifications

Input Impedance

Audio	50k Ω
Video	75 Ω

Output Impedance

Audio	320 Ω
Video	75 Ω

Frequency Response

20Hz to 20kHz	± 0.5 dB
---------------------	--------------

THD+Noise at Rated Output

20Hz to 20kHz	$\leq 0.01\%$
---------------------	---------------

IM Distortion

CCIF at 15kHz and 16kHz	$\geq 0.009\%$
-------------------------------	----------------

Signal to Noise Ratio (at 1kHz "A" weighted)

Ref. to 1V input, max output voltage	> 98 dB
--	-----------

Sensitivity 1 volt output	220mV
---------------------------------	-------

Subwoofer Crossover Frequency	100Hz
-------------------------------------	-------

Crosstalk (@ 1kHz)	> 80 dB
--------------------------	-----------

Maximum Output Voltage	4.6V
------------------------------	------

Tone Controls (L and R front only)

Bass effective below	200Hz
----------------------------	-------

Bass Max Gain/Cut	± 10 dB @ 20Hz
-------------------------	--------------------

Treble effective above	6.3kHz
------------------------------	--------

Treble Max Gain/Cut	± 10 dB @ 20Hz
---------------------------	--------------------

FM Tuner

Usable Mono Sensitivity	15dB μ
-------------------------------	------------

50 dB Mono Quieting Sensitivity	22dB μ
---------------------------------------	------------

50 dB Stereo Quieting Sensitivity	39dB μ
---	------------

A-wtd. Signal to Noise Ratio

Mono	75dB
------------	------

Stereo	70dB
--------------	------

Stereo Separation (1 kHz)	43dB
---------------------------------	------

Alternate Channel Selectivity	> 50 dB
-------------------------------------	-----------

Capture Ratio	2dB
---------------------	-----

General

Power (user selectable 120/230 VAC)	120VAC/50-60Hz
---	----------------

Chassis Dimension	5 ³ / ₁₆ " (132mm) x 17" (432mm) x 13 ³ / ₄ " (349mm)
-------------------------	---

Maximum Dimensions	5 ⁶ / ₁₆ " (137mm) x 17" (432mm) x 15" (381mm)
--------------------------	--

Weight	20 lbs. (9.1kg)
--------------	-----------------

Weight, Packed	23 lbs. (10.4kg)
----------------------	------------------

ADCOM

A division of Klein Technology Group, LLC

8541 East Anderson Drive
Scottsdale, Arizona 85255

Voice: (480) 607-2277

Fax: (480) 348-9876

<http://www.adcom.com>